

PRO 111 | HEAVY-DUTY DRILLING MACHINE

PRO 111 is the newest heavy duty machine with Morse Taper No. 4.

■ Superior features of PRO 111 include:

- purpose designed motor with heavy duty 4-speed gearbox
- maintenance friendly design
- gear box and slide system made as one piece
- maintenance friendly rail guide system

It is designed for cutting holes up to 111 mm (4-3/8") diameter or drilling holes up to 47 mm (1-7/8") diameter.

It has got 4-speed mechanical gear box.

PRO 111 is equipped with motor overload protection system with LED indicator. Its precision and durability are significantly increased thanks to the one piece gearbox housing and slide.









Unique semi-automatic gib adjustment system (patent pending) enables simple, fast and always correct fine tuning without any expert knowledge or experience. Replaceable spline at the end of armature shaft eliminates laborious and expensive armature maintenance. Compact design allows for drilling very close to vertical surface.



PRO 111 is equipped with electromagnetic base featuring magnetic field shape control system (MFSC) and magnetic power adhesion control module (MPAC), which detects adhesive force of electromagnetic base and protects both the machine and the operator from work on too thin workpieces.

Standard shipping set of PRO 111 includes MT4 Arbor with 19 mm (3/4") Weldon Bore which accepts cutters up to 60 mm diameter.

Optional MT4 Arbor with 32 mm (1-1/4") Weldon Bore for cutters of larger diameter is available.

								
Core drill max 111 mm	Twist drill max 47 mm	Thread cutting M30	Spindle MT4	Depth of cut 76 mm	Stroke 230 mm	Speed 85, 135, 160, 250 rpm	Motor Power 1650 W	Weight 31 kg



Max
Ø 111 mm
(4 3/8")



Max
Ø 47 mm
(1 7/8")



Max
Ø 63 mm
(2 1/2")

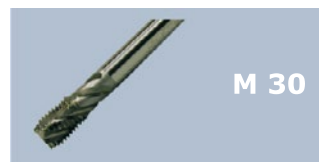

M 30

PRO 111 - Technical specification

Motor Speeds (under load)	85/135/160/250 rpm
Motor Power	1650 W
Weight	31 kg (66 lbs 14 oz)
Max milling capacity	Ø 111 mm (4-3/8")
Max drilling capacity	Ø 47 mm (1-7/8")
Max countersinking	Ø 63 mm (2-1/2")
Max tap size	M30 (tapping attachment required)
Stroke	230 mm (9-1/16")
Max depth of cut	76 mm (3")
Voltage	1~ 110–120 V, 50–60 Hz 1~ 220–240 V, 50–60 Hz
Power consumption	1800 W
Overload protection	yes
Overload LED indicator	yes
Semi-automatic gib adjustment	yes
MPAC	yes
MFSC	yes
Magnetic clamping force	2243 kG (22000 N) /25 mm, Ra=1,25/
Magnet Base Dimensions	120 x 240 x 63 (mm) 4-5/16 x 8-11/16 x 2-3/16 (")
Min. Workpiece Thickness	10 mm (3/8")
Spindle	MT4
Tool holder	19 mm (3/4") or 32 mm (1-1/4") Weldon
Product Code 220–240 V, 50–60 Hz	WRT-0401-10-20-00-0
Product Code 110–120 V, 50–60 Hz	WRT-0401-10-10-00-0

Standard shipping set:

- Magnetic base drilling machine
- Metal Box
- MT4 Arbor with 19 mm Bore - Through Spindle Continuous Cooling
- Swarf Shield/Cutter Guard
- Coolant Bottle Assembly
- Safety Chain with Snap Hook, Set of Tools with Wedge
- Operator's Manual (English)
- Standard shipping weight – 38,2 kg (82 lbs 6 oz)

Selected additional accessories:

- UCW-0191-02-00-00-0 Through Spindle Continuous Cooling Arbor AMT4-U32/4-3
- PDS-0111-03-00-01-0 DMP0501 Pipe Attachment



PRO-111 gearbox:

- MT4 spindle
- High torque up to 178Nm
- 4 powerful mechanical motor speeds
- Through spindle cooling

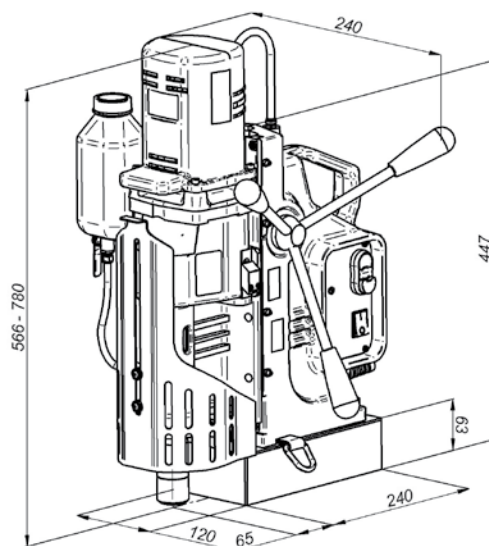

All information is subject to change without notice. 1708



PROMOTECH Sp. z o.o.
ul. Elewatorska 23/1, 15-620 BIAŁYSTOK, POLAND
tel. (+48 85) 678 34 05, fax (+48 85) 662 78 77
marketing@promotech.eu www.promotech.eu

Your local dealer:

